

# Haunted Hill Farm®

Presents our ghoulish collection of Halloween décor from

## FRASER HILL FARM

Thank you for choosing Haunted Hill Farm!  
If you have any questions, concerns or suggestions, please  
contact us directly.

**Boo@HauntedHillFarm.com** (Anytime)

**1-888-840-4559**

(9AM to 9PM Eastern Time, Monday - Friday)

(9AM to 5PM Saturday - Sunday)

In the unlikely event that you experience a problem, please provide pictures and a description of the problem, a receipt (if available), name and address of the purchaser and the name of retailer where you purchased the product.

**Please do not return this item to the retailer.**

See the full Haunted Hill Farm collection and get online support for assembly, troubleshooting, care and maintenance at:

**[www.HauntedHillFarm.com](http://www.HauntedHillFarm.com)**

Please follow the step by step guide and enjoy Axe Girl™!

HHAXEGIRL-5FLSA



The model number of your item is printed on the side of your carton.  
Always use this number to identify your item.

Thank you for your purchase of this quality Halloween decor. With proper use and care, your Halloween decor will provide you with years of enjoyment. Please follow the instructions on how to assemble and disassemble your item. If you should have any problems with your item, or you have any questions, **DO NOT** return it to the place of purchase. Please call our toll-free number: **1-888-840-4559** and a customer service representative will assist you. Enjoy your Holiday!

## PARTS LIST

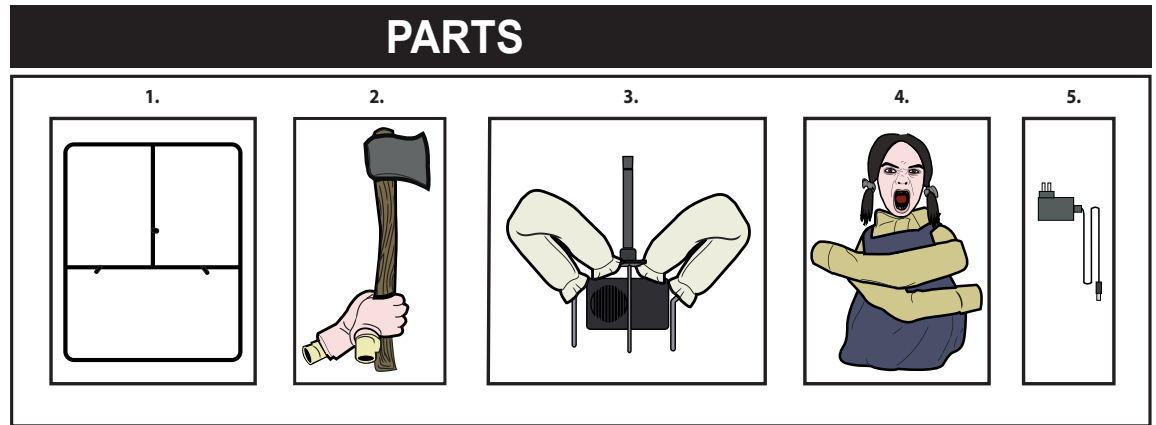

### PARTS

- 1: METAL STAND
- 2: AXE AND HANDS
- 3: CONTROL BOX AND LEGS
- 4: BODY AND MODULE
- 5: 6V 2A ADAPTER

**BEFORE ASSEMBLING, REMOVE ALL THE ABOVE PARTS FROM BOX. IF ANY PART IS MISSING, DO NOT ATTEMPT TO ASSEMBLE THE PRODUCT. CONTACT CUSTOMER SERVICE AT [BOO@HAUNTEDHILLFARM.COM](mailto:BOO@HAUNTEDHILLFARM.COM), OR BY PHONE FROM 9:00AM TO 5:00PM EST AT 1-888-840-4559.**

### CARE AND STORAGE INSTRUCTIONS

When the product not in use, store in its original packing after it is completely dry.  
Keep away from heat.

Please read all instructions carefully before assembling. Save this instruction sheet for future reference.

### WARNING

This item is not a toy and should be used for decoration only. This item contains small parts that can be a choking hazard. Keep all plastic and wire parts away from children. Recommended for ages 15 and up.

1. Please use the adapter supplied by manufacturer.
2. Please assemble item according to instructions. Connect all wires according to matching letter.
3. Children should be supervised by adults. Item should not be grabbed, as it becomes a tipping hazard. Keep all away from the adapter, as it heats up during operation.
4. This item contains Polyvinyl Chloride (PVC).
5. Colors, style and contents may vary slightly from those shown on the package.

### SMART PHONE SCAN

SETUP VIDEO



# ASSEMBLY INSTRUCTIONS

## ASSEMBLY

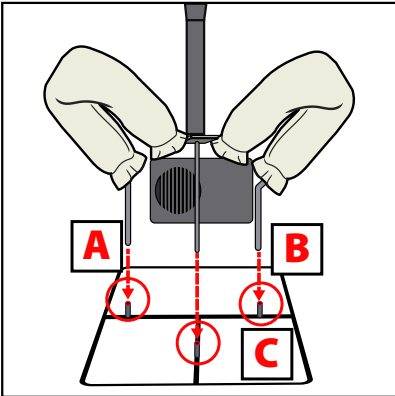

1. Line up the CONTROL BOX AND LEGS with the METAL STAND. (Match A to A) (Match B to B) (Match C to C) For optimal performance make sure METAL STAND is on flat even ground.

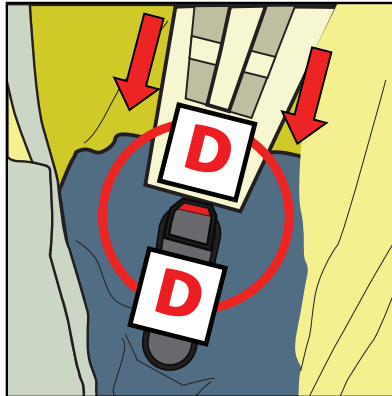

2. Open the back of the dress on the BODY AND MODULE. Connect the BODY AND MODULE to the pole on the CONTROL BOX AND LEGS. (Match D to D)

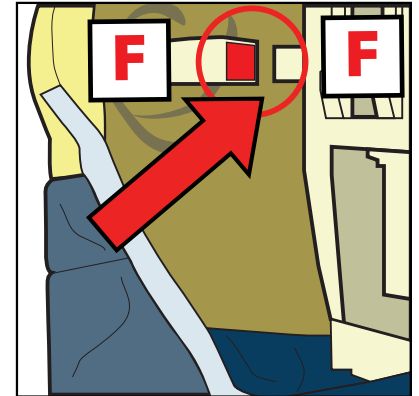

3. Reach inside the BODY AND MODULE and connect the left arm to the module. (Match F to F)

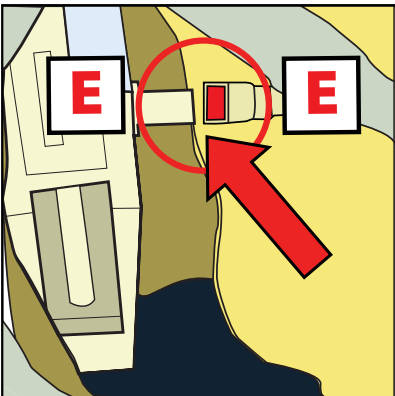

4. Reach inside the BODY AND MODULE and connect the right arm to the module. (Match E to E)

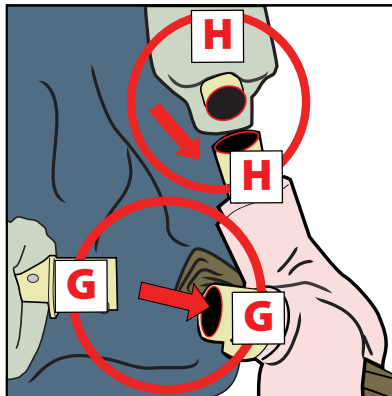

5. Insert the ends of both arms on the BODY AND MODULE into the AXE AND HANDS. (Match G to G) and (Match H to H)

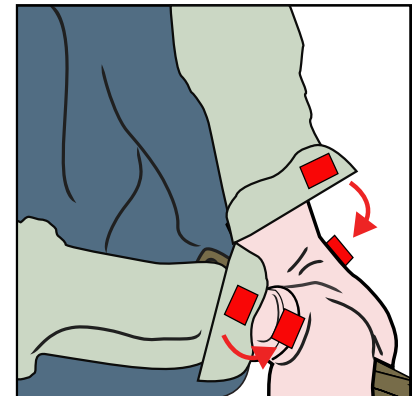

6. Attach hook and loop fasteners located in both sleeves to the wrists on the AXE AND HANDS.

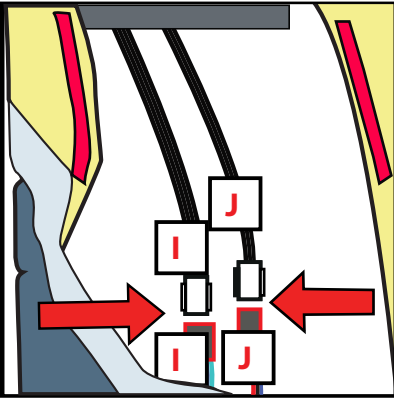

7. Connect the wires labeled I and J located on the CONTROL BOX AND LEGS to the wires on BODY AND MODULE. Close hook and loop fasteners on the back of the dress. Match I to I- (Hands movement) Match J to J- (Motion sensor)

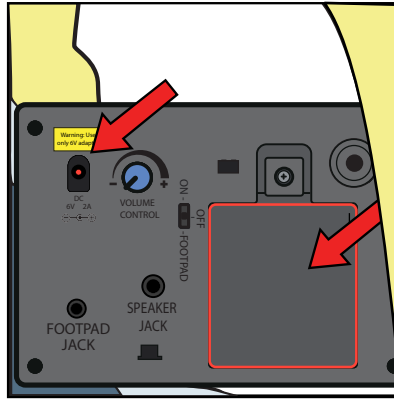

8. Connect 6V 2A ADAPTER (included) or insert 4 AA alkaline batteries (not included) into the battery compartment located on the CONTROL BOX.

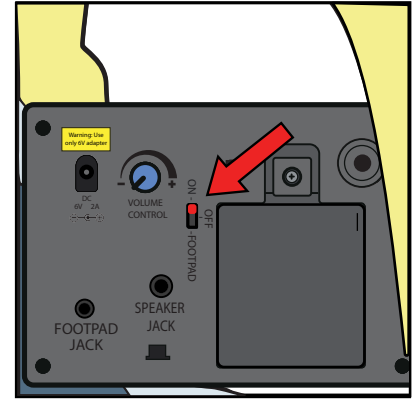

9. Turn the switch to the ON position to operate in Sound and Motion activation mode. Move in front of the item or make a loud sound (clap) to activate the item. Turn item OFF when not in use.

**\*\*\*WARNING\*\*\***

**STAND BACK FROM ITEM WHILE OPERATING, AND KEEP CHILDREN BACK!  
AXE SWINGS DOWN QUICKLY!**

**OPTIONAL FOOTPAD SET UP**

**FOOTPAD IS NOT INCLUDED. MUST BE PURCHASED SEPARATELY.**

1. Insert the cable from optional footpad into the jack labeled FOOTPAD JACK on the CONTROL BOX.
2. Place the switch in the FOOTPAD position to enable FOOTPAD activation.
3. Step on the FOOTPAD to activate the scary sequence!



**OPTIONAL EXTERNAL SPEAKER SETUP**

1. This prop can be played through an external speaker (sold separately). Connect the wire from your external speaker to the jack labeled SPEAKER JACK on the control box
2. Adjust the volume knob on external speaker to control volume levels.

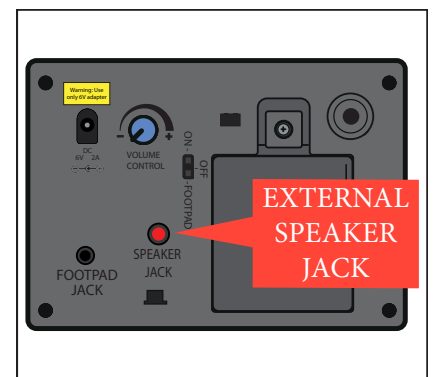



## Warnings

- This product is for decoration only and is not a toy. Small parts and choking hazard. Use caution with children under the age of 15.
- Do not position the decoration near candles, sources of heat, or in direct sunlight.
- The decoration cannot be connected to the power supply directly.
- Decoration should be on a level, stable surface to prevent it from falling over.
- This product is fragile and should be assembled with care.
- Surface washable only.
- Please follow the steps and requirements specified in the instruction to ensure safety and reliability during the installation.

### Battery Diagram

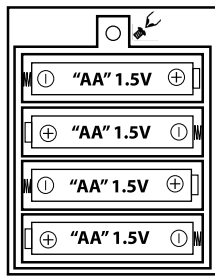

### BATTERY INSTRUCTIONS AND CAUTIONS

Battery installation and removal should be performed by an adult.  
Remove batteries when not in use.  
Use only batteries recommended in the instructions.  
Do not mix new and used batteries.  
Do not mix alkaline, carbon-zinc, nickel-cadmium, rechargeable or different types of batteries.  
Be mindful to insert batteries with the correct polarity (+/-) as indicated.  
Remove all exhausted batteries.  
Rechargeable batteries are only to be charged under adult supervision.  
Rechargeable batteries are to be removed from the item before being charged.  
Non-rechargeable batteries are not to be recharged.  
The supply terminals are not to be short-circuited.  
Always dispose of exhausted batteries properly.  
Do NOT dispose of batteries in fire, they may leak or explode.

**Warning! This item is not a toy. For decoration only. Small parts, choking hazard.  
This product is intended for use by persons 15 years of age and older.  
Not intended for use by children ages 14 years and younger.**

### WARNING

**DO NOT TURN ITEM ON UNTIL YOU HAVE COMPLETELY FINISHED ASSEMBLY.  
STAY CLEAR OF ITEM WHILE OPERATING.  
DO NOT PLACE ITEM ON UNEVEN GROUND.  
DO NOT PLACE WEIGHT ON ITEM WHILE IN OPERATION  
\*\* FOR INDOOR USE ONLY\*\***

**Storage tips:** We suggest saving the carton for storing your figurine. Store in a cool, dry area where the temperature does not exceed 100°F.

# 1-YEAR LIMITED WARRANTY

## "Limited" Warranty Program

For a period of one (1) year after purchase, Haunted Hill Farm ("Manufacturer") will either repair or replace defective components in accordance with this Limited Warranty.

**Sales and use taxes, plus shipping and handling charges are the responsibility of the consumer.**

This warranty is between Manufacturer and the original purchaser and is valid only when accompanied by the original purchaser's sales receipt showing original date of purchase and location of purchase. Replacements under this warranty revert back to the date of original purchase for future warranty.

Manufacturer or its authorized dealer can accept or reject warranty claims based on its findings. This warranty applies in normal residential use only, where an issue with the product is due to a defect in material or workmanship. Manufacturer can make substitutions as required of materials, components, and sub-components of comparable value and utility. This warranty is limited to product repair or replacement (to be determined solely by Manufacturer). Warranty return is limited to only the single affected component.

This warranty covers only manufacturing defects and does not cover normal wear and tear, abuse or misuse, including: water damage, chemical damage, exposure to extreme heat or cold, abrasion or excessive weight. This product is intended to be used with standard ornaments only. This warranty is invalid if the product is not used for intended purpose. Manufacturer disclaims liability for any aspect of installation and any inconvenience caused by a defective part or component.

**Certain items are not covered by this warranty. These include, but are not limited to the following:**

1. Components subjected to abuse, including abuse intended to simulate failure.
2. Damages caused by retailer, shipper or installation crew (such as scratches, dents, tears, etc.).
3. Any part which merely exhibits normal wear yet functions essentially as new, including stretching of materials and stitching.
4. Tears, punctures, scratches or any damage caused by improper installation or use.
5. Items sold "as is" or floor models.

To make a claim, send a copy of the original sales receipt along with a brief description of the problem to the email address below. Please include your email address and daytime telephone or cell phone #. All items maybe charged actual freight and handling costs. Repairs or replacement will be made at the Manufacturer's option.

**THIS IS THE ENTIRE EXCLUSIVE EXPRESS LIMITED LIABILITY. THE MANUFACTURER NEITHER MAKES NOR IS RESPONSIBLE FOR ANY OTHER WARRANTIES, EITHER EXPRESS OR IMPLIED, INCLUDING THOSE OF RETAILING DEALERS. THIS EXCLUSIVE REMEDY IS LIMITED TO RECEIPT OF A CREDIT IN CONNECTION WITH THE REPAIR OR REPLACEMENT OF ANY PRODUCT OR COMPONENT DEEMED TO BE DEFECTIVE UNDER THE TERMS AND CONDITIONS AS STATED IN THIS WARRANTY. NEITHER HAUNTED HILL FARM, THE PRODUCT MANUFACTURER NOR ITS AGENTS SHALL BE LIABLE IN ANY CASE FOR INCIDENTAL, INDIRECT, SPECIAL OR CONSEQUENTIAL DAMAGES RESULTING FROM THE USE OF THIS PRODUCT OR ARISING OUT OF ANY BREACH OF THIS WARRANTY OR NEGLIGENCE EVEN IF IT HAS BEEN ADVISED OF THE POSSIBILITY OF SUCH DAMAGES. EXCEPT AS OTHERWISE MAY BE REQUIRED BY LAW, THERE ARE NO OTHER EXPRESS OR IMPLIED WARRANTIES OTHER THAN THE WARRANTY DESCRIBED HEREIN, AND ALL OTHER WARRANTIES, INCLUDING ANY IMPLIED WARRANTY OF MERCHANTABILITY OR FITNESS FOR A PARTICULAR PURPOSE ARE EXPRESSLY DISCLAIMED.**

**Boo@HauntedHillFarm.com**